

White Retrofit for Fresnel De Sisti

Leonardo (COD.320-321)



- **Easy installation** - (remove the lamp holder slide box, remove the reflector, remove the lamp holder, insert the module and secure it with 2 M4 screws, fix the display box (time required 9/11 minutes)
- **Light quality** - (high colour rendering CRI >97, constant colour temperature, flicker free
- **Consumption** - electrical connection (low consumption, maximum power consumption 230W)
- **Dimming** - (Power supply directly connected to the network 110/240 V~, dimming control through the 8 or 16 bits DMX control, adjustment of the reaction times, quick reaction, dimming curves, always with a uniform and smooth operation, without jumps even at the lower light level, RDM control)
- **Heat** - (drastic temperature reduction of the projector unit resulting in savings for air-conditioning)
- **Maintenance** - (savings for lamps replacement, lamp average life 300/500 hours, depending on the model, Led life 50,000 hours, as estimated by the manufacturer)
- **Noise** - (efficient and silent cooling, with possibility to adjust the fan speed)
- **Protections** - (inner active control system which adjusts the operation of the unit by controlling the temperature thus protecting it in any situation)
- **Versions** - (a complete range with a variety of versions in order to meet all needs, available with 3000°k, 4000°k, 5600°k white light, white variable from 3000° to 5700°k, coloured RGBACL, red, green, blue, amber, cyan, lime)
- **Made in Italy** -(made and assembled in Italy using reliable and high quality components)

Technical specifications

| | | |
|---|---|---------------------------------------|
| Power Supply: 100–240V ~ 50/60Hz auto-setting (single-phase) | | |
| Maximun power consumption 230W | Minimun room temperature: -10°C | |
| Stand-by power consumption 5W | Maximum room temperature: 35°C | |
| Minimun CRI : 90 > and 97 > (depending on LED model) | LED life 50.000 Hrs (see manufacturer's specifications) | |
| LED K° colour temperatures: 3000°K; 4000°K; 5600°K (specify when ordering) | | |
| Protection grade:IP20 | Working position: any | |
| Data Protocols: DMX 512, and-or RDM ready | User's interface: 4-digit display and 4 keys | |
| Data connectors: IN – OUT Neutrik XRL 5 | | |
| Control of led frequency: selection of LED frequency refresh | Fan control: fan speed adjustments | |
| Manual operations: via keys provided on the display | | |
| Dimming curves control: selection of two dimming curves control | | |
| Net weight: 2,7 kg | Packed weight: 3,3 kg | Packaging volume 0.015 m ³ |
|  | | |
| Compliant to : | | |

Photometric data LED 5600°K CRI 97 (Leonardo cod. 320-321)

Statistics rates measured with the use of 5600°K CRI 97 LED lantern in use for 30 minutes at 25°C room temperature

| | Distance m | 4 m | 6 m | 8 m | 10 m | 12 m | 14 m |
|-----|--------------|--------------|--------------|--------------|--------------|--------------|--------------|
| 16° | Lux | 8.644 | 3.842 | 2.161 | 1.383 | 960 | 706 |
| | Diameter ø m | 1,12 | 1,68 | 2,24 | 2,81 | 3,37 | 3,93 |
| 66° | Lux | 1.663 | 739 | 416 | 266 | 185 | 136 |
| | Diameter ø m | 5,19 | 7,79 | 10,39 | 12,98 | 15,58 | 18,18 |

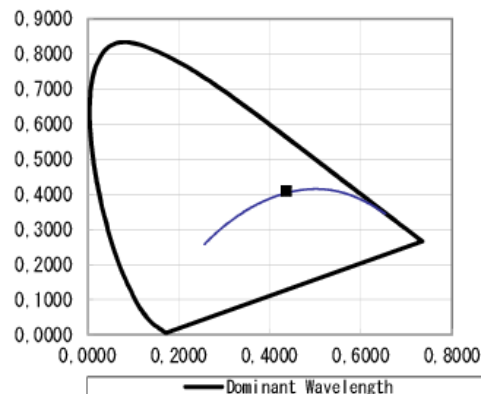
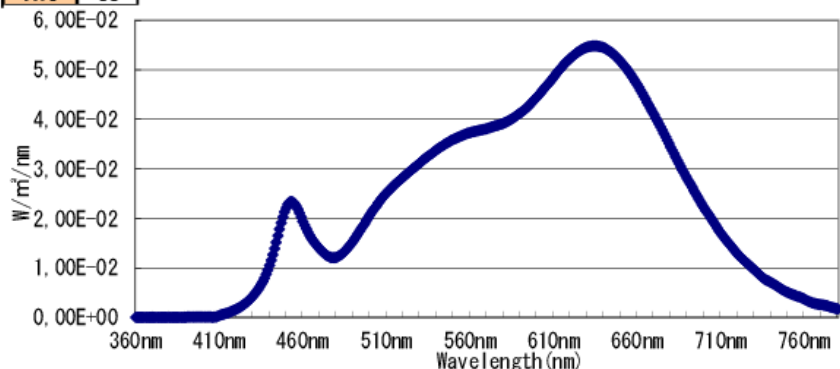
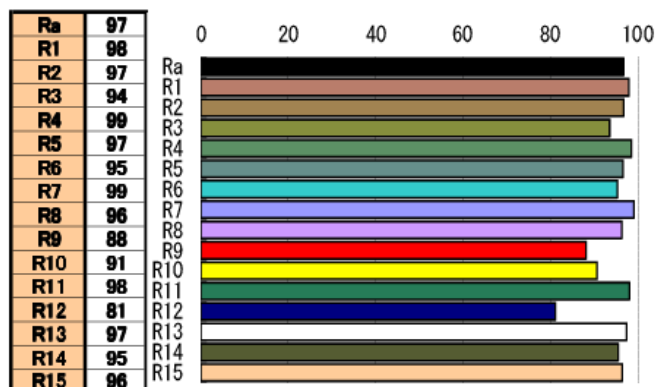

HPLED DE

“white series”

Lites s.r.l.

Simply LED to innovation

Photometric data LED 3000°K CRI 97 (Leonardo cod. 320-321)

Statistics rates measured with the use of 3000°K CRI 97 LED lantern in use for 30 minutes at 25°C room temperature

| | Distance m | 4 m | 6 m | 8 m | 10 m | 12 m | 14 m |
|-----|--------------|-------|-------|-------|-------|-------|-------|
| 16° | Lux | 7250 | 3.222 | 1.813 | 1.160 | 806 | 592 |
| | Diameter ø m | 1,12 | 1,68 | 2,24 | 2,81 | 3,37 | 3,93 |
| 66° | Lux | 1.394 | 619 | 348 | 223 | 155 | 114 |
| | Diameter ø m | 5,19 | 7,79 | 10,39 | 12,98 | 15,58 | 18,18 |

| | |
|-----|----|
| Ra | 97 |
| R1 | 97 |
| R2 | 96 |
| R3 | 93 |
| R4 | 96 |
| R5 | 95 |
| R6 | 92 |
| R7 | 98 |
| R8 | 98 |
| R9 | 93 |
| R10 | 90 |
| R11 | 95 |
| R12 | 74 |
| R13 | 97 |
| R14 | 96 |
| R15 | 97 |

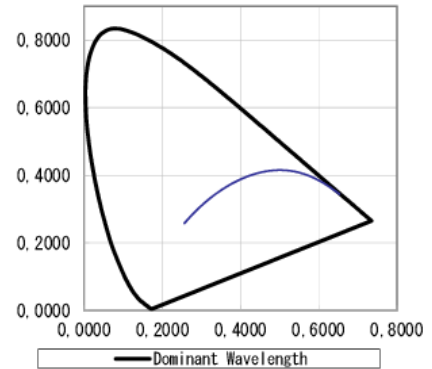
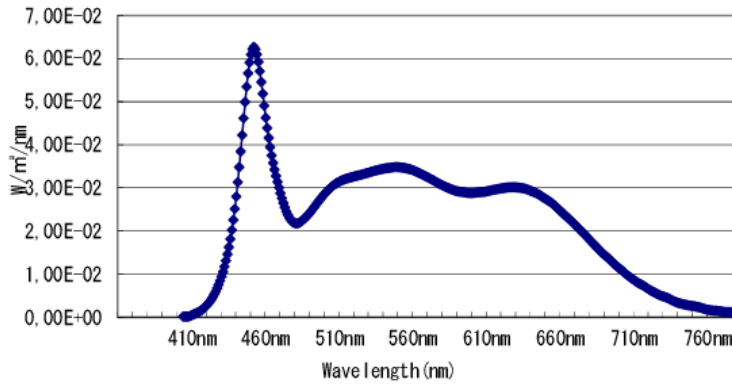
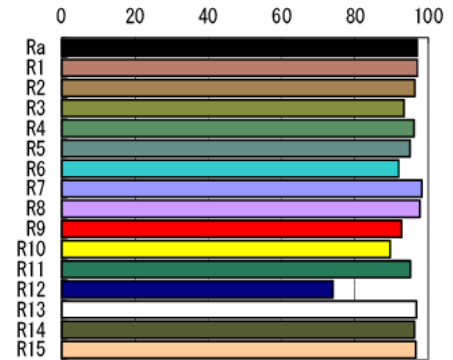
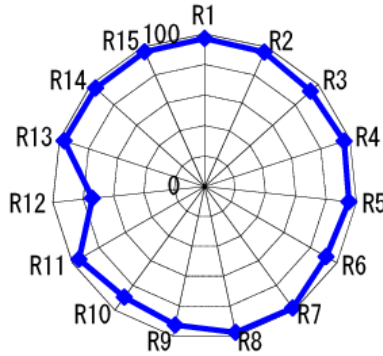

Dimensions:

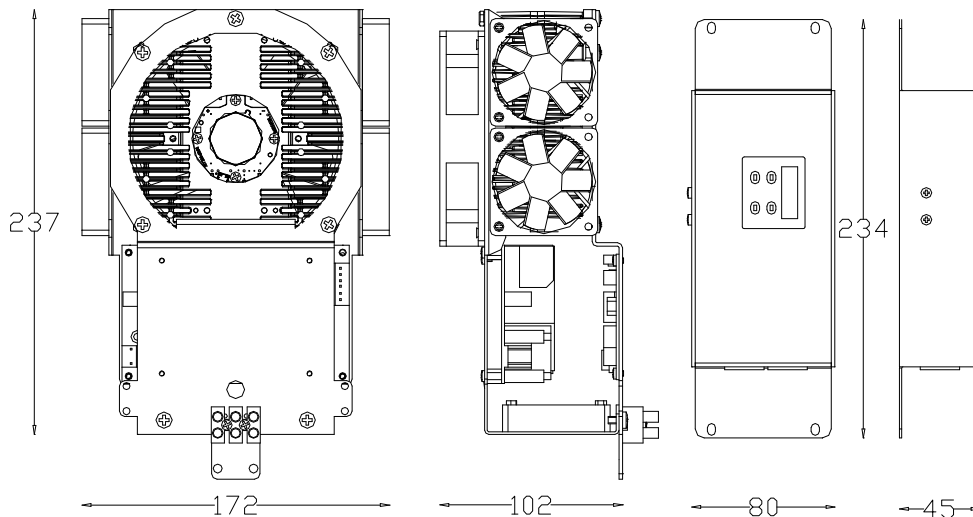

The information contained in this document has been carefully drawn and checked. However, the manufacturer shall not be liable for any inaccuracy or mistake. Lites srl reserves the right to modify or make any functional change at any time without notice.