

Lites s.r.l.

for more information
contact us
info@litesrl.com

www.litesrl.com
www.professionallighting.eu



Lites F200 PO

"Pole operated White Series"

SIMPLY LED TO INNOVATION

Lites F200 (Standard), Lites F200 zoom (motorized zoom) and Lites F200 PO (Pole-Operated) are Fresnel luminaire fixtures that integrate a 200W cutting-edge LED light-source.

The Light output of LitesF200's may be compared to traditional 1200W tungsten fixture but with the rewarding low power consumption of only 200W. The sturdy die-cast aluminium body makes the Lites F200 aesthetically an eye-catching product and employs optimal heat dissipation while the on-board helicoidal-screw allows for ample 20°- 60° beam angle adjustment.

The motorised Zoom model does away with manual operation and ensures uniform motions.

The pole PO version uses a the DeSisti pole PO yoke system.

The Lites F200 is a totally flicker-free fixture and uses 16-bit dimming as well as a silent fan with adjustable speed control.

All LitesF200 models may be operated via either DMX and/or ready RDM protocols.

The user friendly digital display facilitates operators' needs.

Product of Italy. (Designed and manufactured by Lites srl).





Technical specifications

Power Supply: 100 – 240V ~ 50/60Hz auto-setting (single-phase)		
Maximun power consumption 200W	Minimum room temperature: -10°C	
Stand-by power consumption 5W	Maximum room temperature: 35°C	
Led life 50.000 Hrs (see manufacturer's specifications)	Maximun body temperature: 60°C	
LED K° colour temperatures: 2700°K; 3000°K; 4000°K; 5600°K (specify when ordering)		
Beam angle: 20° - 60° via helical screw		
Minimum CRI : 90 > and 97 > (depending on LED model)	Protection rating: IP20	
Die-aluminium body to maximize heat dissipation	Working position: +90°/-90° on vertical axe	
Rear handle for good grip of unit: side-lock on mouting yoke to adjust and set unit to position		
Fresnel lens ø150 mm	Colour-frame gate dimensions: 185x195 mm	
Data Protocols: DMX 512, and-or RDM ready	User's interface: 4-digit display and 4 keys	
Power connectors: IN – OUT neutrik power-con connectors	Data connectors: IN – OUT neutrik XRL 5	
Control of led frequency: selection of led frequency refresh	Idle fan mode for totally silent use of the unit	
Dimming curves control: selection of two dimming curves control		
Manual operations: via keys provided on the display		
Unit net weight: 9 kg	Gross weight 10 kg	Cubical volume: 0,096 m ³
Compliant to:		

Photometric data LED 3000°K CRI 97

Statistics rates measured with the use of 3000°K CRI 97 LED lantern in use for 30 minutes at 25°C room temperature

	Distance m	4 m	6 m	8 m	10 m	12 m	14 m
Angle 20°	Lux	4244	1886	1061	679	472	346
	Diameter ø m	1,12	1,68	2,24	2,81	3,37	3,93
Angle 60°	Lux	1539	684	385	246	171	126
	Diameter ø m	4,61	6,9	9,2	11,5	13,8	16,1

Ra	97
R1	99
R2	97
R3	93
R4	99
R5	97
R6	96
R7	99
R8	98
R9	92
R10	91
R11	98
R12	82
R13	98
R14	95
R15	98

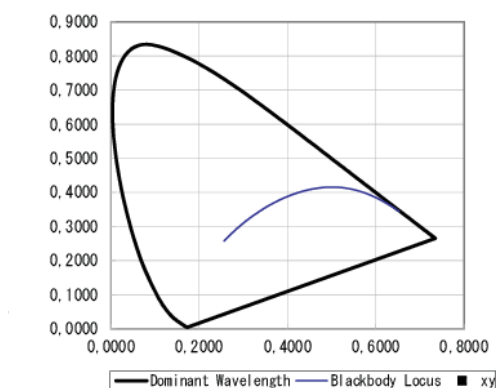
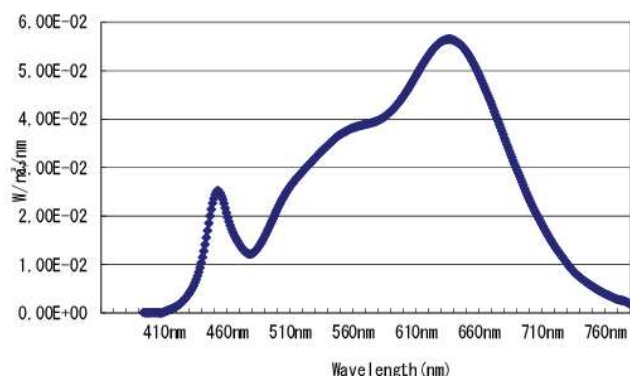
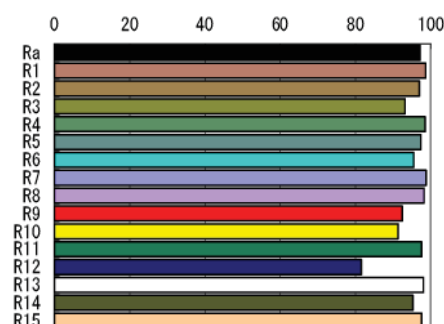
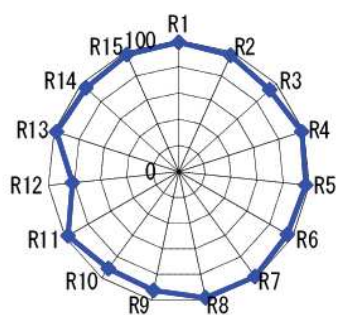



Lites F200 PO

"Pole operated White Series"

Photometric data LED 5600°K CRI 90

Statistics rates measured with the use of 5600°K CRI 90 LED lantern in use for 30 minutes at 25°C room temperature

Distance m		4 m	6 m	8 m	10 m	12 m	14 m
Angle 20°	Lux	5038	2239	1259	806	560	411
	Diameter ø m	1,12	1,68	2,24	2,81	3,37	3,93
Angle 60°	Lux	1823	810	456	292	203	149
	Diameter ø m	4,61	6,9	9,2	11,5	13,8	16,1

Ra	90
R1	86
R2	90
R3	91
R4	87
R5	86
R6	84
R7	94
R8	83
R9	55
R10	74
R11	86
R12	61
R13	87
R14	95
R15	84

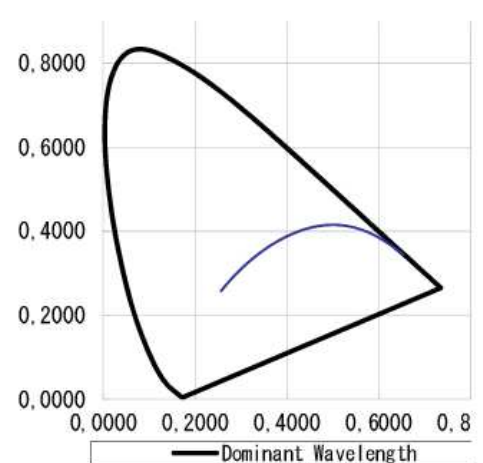
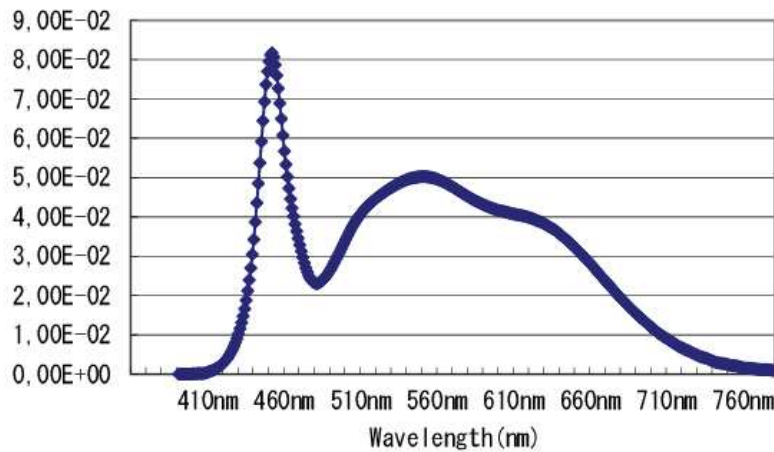
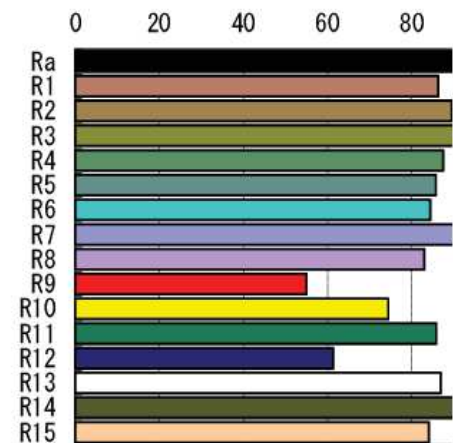
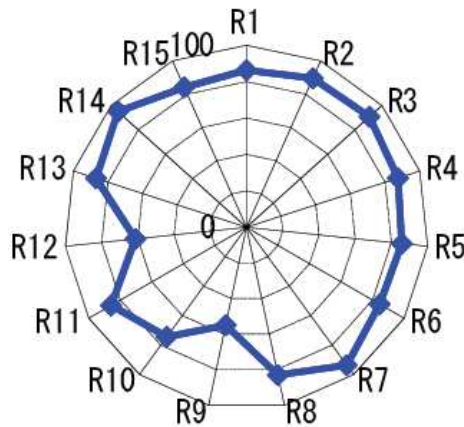

Photometric data LED 5600°K CRI 97

Statistics rates measured with the use of 5600°K CRI 97 LED lantern in use for 30 minutes at 25°C room temperature

Distance m		4 m	6 m	8 m	10 m	12 m	14 m
Angle 20°	Lux	4441	1974	1110	711	493	363
	Diameter ø m	1,12	1,68	2,24	2,81	3,37	3,93
Angle 60°	Lux	1606	714	402	257	178	131
	Diameter ø m	4,61	6,9	9,2	11,5	13,8	16,1

Lites s.r.l.

for more information
contact us
info@litesrl.com

www.litesrl.com
www.professionallighting.eu



Lites F200 PO

"Pole operated White Series"

Ra	97
R1	97
R2	96
R3	93
R4	96
R5	95
R6	92
R7	98
R8	98
R9	93
R10	90
R11	95
R12	74
R13	97
R14	96
R15	97

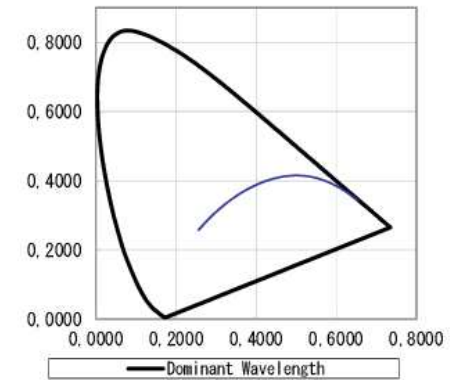
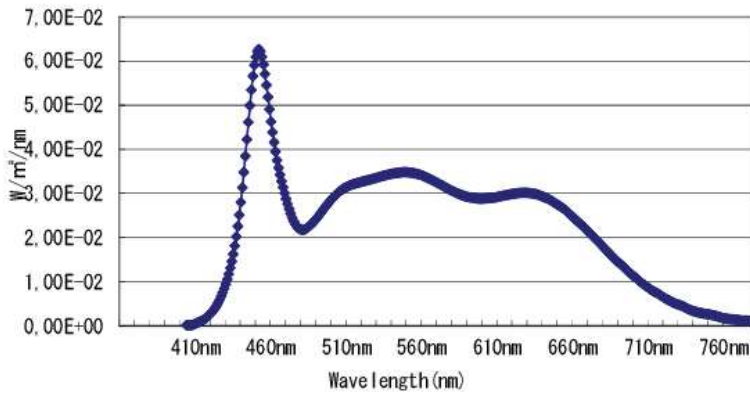
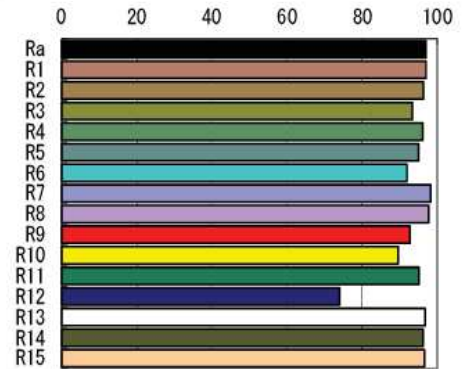
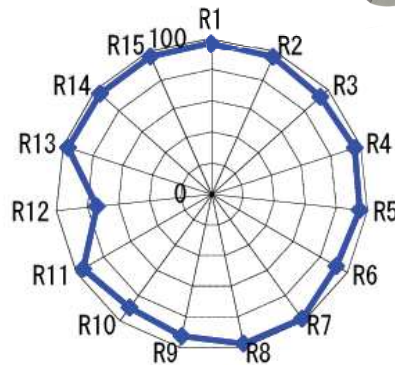

Dimensions:

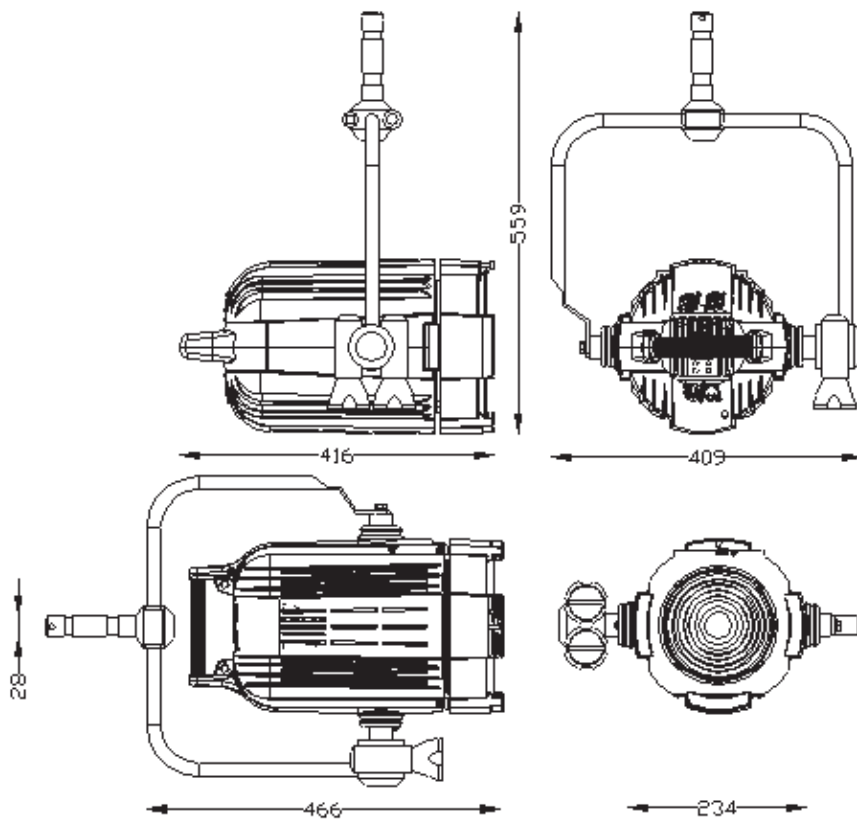

Data provided are informative only and not binding. Values data and other information may be changed without notice.