

# Lites

## HPLED DE C6

### Colour RGBACL

Retrofit for Fresnel  
LEONARDO 2000 cod. 320-321 (De Sisti)  
Owner's and service manual



Read this manual totally and carefully follow all the instructions contained. File this manual for future use. It is essential to read all the information contained to ensure correct installation, service and full operation of the HPLED DE C6  
All operations must be accomplished, handled and carried out by qualified personnel only.

**NOT COMPLYING WITH GIVEN NOTICE IT WILL VOID WARRANTY AND WILL FREE THE MANUFACTURER OF ANY KIND OF RESPONSIBILITY AND LIABILITY.**

## Unpacking

Unpack the carton and gently remove HPLED DE C6 from the box. Ensure HPLED DE C6 is received in all its parts. In the event the HPLED DE C6 shows any damage, do not use it and contact immediately your transporter as well as your seller.

Items in the carton consist of:

- N. 1 HPLED DE C6 unit
- N. 2 Ø 4 mm washers
- N. 2 M4 screws

Installation, utilisation and service owner's manual.



**General Information and recommendation to operate the unit in good and safe conditions.**

**Follow instructions with care and attention:**

HPLED DE C6 must be used and housed only and exclusively for the 2000W Leonardo unit (code 320 – 321)

**The HPLED DE C6 unit must NEVER be used unless it is housed in one of the models listed above. (Fresnel Leonardo cod. 320-321).**

HPLED DE C6 fixture is only meant for professional use. NEVER use it for domestic or other improper use.

Minimum distance from any flammable source is of 0.25m.

Minimum throw distance from illuminated surface: 0.5m.

The installation of the unit(s) (prior to installation, the HPLED DE C6 unit must be housed in one of the De Sisti luminaires listed above), the housing of the external fixture body, must be secured with suitable clamps, safety cords and adequate protection.

Install HPLED DE C6 in ventilated ambient which temperature must not exceed 35°C

HPLED DE C6 is NOT for domestic use, HPLED DE C6 can only be used for professional applications.

When HPLED DE C6 unit is operated, some outer parts of the profile can reach temperatures of up to 60°C

HPLED DE C6 must be fitted with protection shields (Lenses)

On no account, directly or indirectly, LED must be touched as it may impair its use.

An Essential and Periodically throughout cleaning of the HPLED DE C6 is recommended. This practice avoids that layers of dust and other impurity jeopardise and reduce the correct operation of the unit. Lenses must be cleaned to remove layers of dust that may impede and or reduce the passage of the light through the lenses. The correct and periodically maintenance keeps also fans and vents clean thus keeping the HPLED DE C6 in its best performance conditions. Never touch, directly or indirectly, the Yellow core of the LED nor use solvents that can damage the LED irretrievably. Protection shields if battered/worn, must be replaced with new ones (Lenses)



**Warning from electric shocks**

All operations must be accomplished, handled and carried out by qualified personnel only

**Warning High voltage hazard, always disconnect Power before any handling and any servicing of HPLED DE C6**

Do not and never handle HPLED DE C6 with humid/wet hands or near to any water or any kind of moisture sources

Always connect HPLED DE C6 to mains fitted with safety device switch that cuts power off in case of danger

**The HPLED DE C6 does NOT and CAN NOT be operated via Phase control dimmer nor connected/operated in NON-DiM mode**

HPLED DE C6 is rated Class I

**Earth connection is mandatory!**

## CE Approvals

The HPLED DE C6 products to which this manual refers to, complies with European directive pursuant to:

2014/35/EU safety of electrical equipment supplied at low voltage (LVD)

2014/30/EU Electromagnetic compatibility (EMC)

2011/65/EU Restriction of the use of certain hazardous substances (RoHS)

## WARRANTY!

A 24-month warranty is granted on the HPLED DE C6 from purchase's date. Warranty covers fabrication defects only. Warranty is immediately voided if the HPLED DE C6 has been handled by unqualified personnel. Any improper and unauthorised use, such modification(s) or misapplication of the HPLED DE C6 will also void the warranty of the product(s). Silver colour label showing technical data and serial number, if removed or if data are impaired to render details illegible, it will immediately void the warranty

## Technical specifications

Power Supply 100-240 V~ 50/60Hz

Maximum power consumption 200W

Stand-by power consumption 3W

Minimum ambient temperature -10°C

Maximum ambient temperature 35°C

LED Colour RGBACL: Red; green; blue; amber; cyan; lime

30 colored presets

10 white presets from 2,300°K to 10,000°K

LED CRI: *Minimum CRI*: 93> and 98>(depending on the selected white)

10 white presets from 2,300 ° K to 10,000 ° k

LED Life (see Manufacturers ' specifications)

Weight: 2,7 Kg

IP20 rating: To be housed into original Fresnel Leonardo 2000w De Sisti 320-321 series luminaire

Working position: Any

Data connectors: IN & OUT XRL5

Data protocols: DMX 512; RDM ready

User interface: 4-digit display and 4 buttons

Manual operation: Users must operate via buttons provided on the display

Fan control: Fan speed adjustment

Control of LED frequency: Selection of LED frequency refresh

4 Dimming curves control: Selection of four dimming curves control

Compliant: **CE**

Dimensions (see picture):

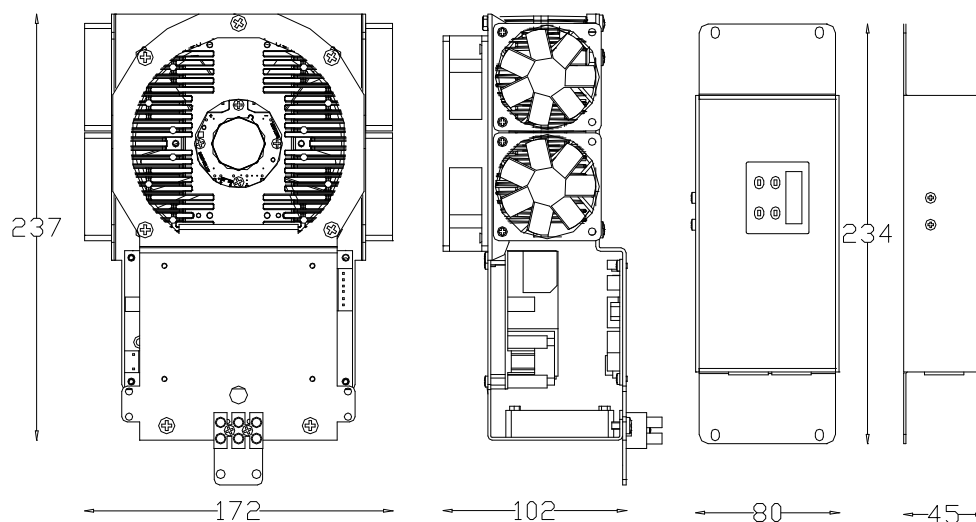

**⚠ It is mandatory to disconnect power from mains during the whole process installation of the HPLED DE C6 module.**

The HPLED DE C6 module has been designed to replace the halogen lamps used in the 2000 W Fresnel De Sisti Leonardo model projectors (codes 320 and 321) with a fully LED gear. Place the projector on an even surface with the base of the projector facing up. (see fig. 1). Loosen the 4 M4 screws that secure the lamp-holder, slide the box and remove the slide-holder-box from the projector (see fig. 2). Remove the mirror holder and the G38 lamp-base. Loosen the 2 M4 screws that holds the mirror-holder in place (see fig. 3) and as well the 2 M4 screws that holds the lamp-holder to the slide (see fig. 4). Use the 4 mm Allen-key to loosen the screws that hold the power cables to the lamp-holder. Loosen the M4 screw that holds the yellow/green ground-cable to the lamp-holder. Cut the eyelet lug from the ground cable. Drill the slide box at the indicated heights with a drill using a 20/25 mm drill-bit (see fig. 5). Hold the HPLED DE C6 module and connect the power cables to the three-pole terminal, ensure connection to the ground-cable (central terminal) and the power cables to the side terminals. Secure the power cables with the supplied clamps (see fig.6). Secure the HPLED DE C6 module to the slide with the use of 2 M4 screws (see fig. 7). Lead the DMX cables and the display-strip through the hole previously drilled (see fig. 8). Connect the strip to the display and the DMX connector to the HPLED DE C6 display holder-box (see fig. 9). Secure the signal cables with the supplied cable-tie. Remove the 4 side screws from the sled holder-box and fix the display box to the projector sled holder (see fig.10). Insert the assembled slide box into the Fresnel projector (see fig.11). Close the slide box with the 4 M4 screws (see fig.12).



Fig.1

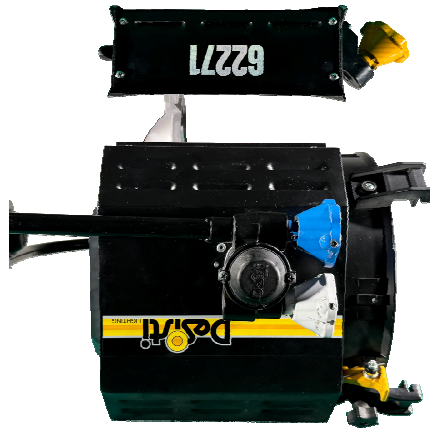

Fig.2



Fig.3

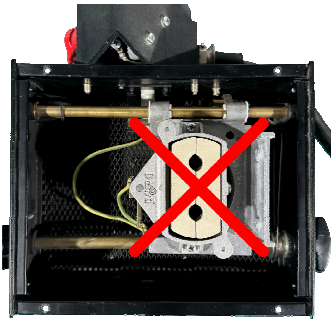

Fig.4

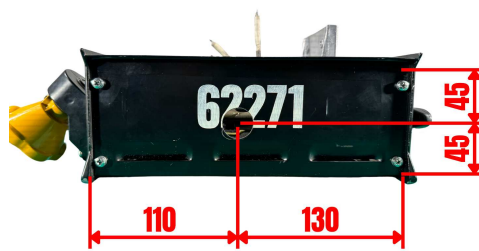

Fig.5

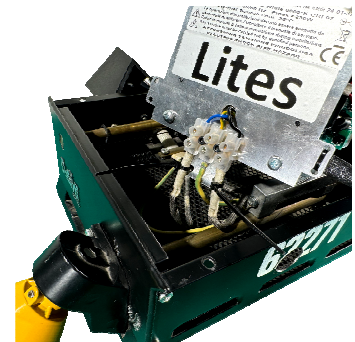

Fig.6



Fig.7

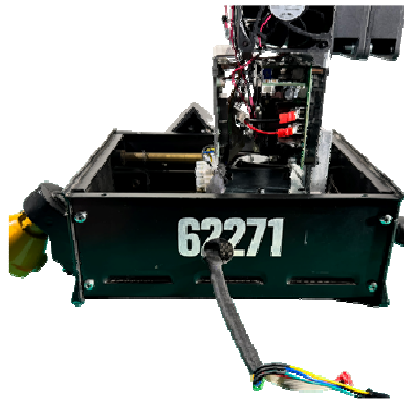

Fig.8

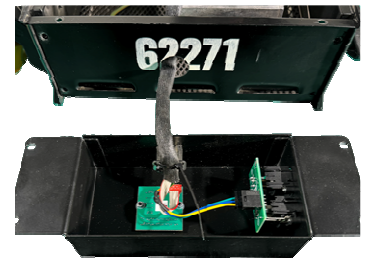

Fig.9



Fig.10

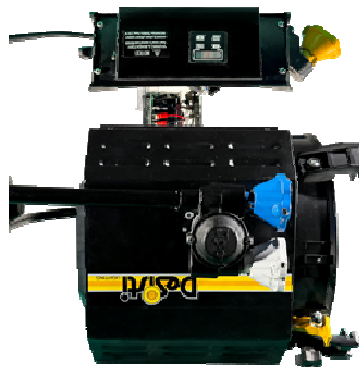

Fig.11



Fig.12

## Connection to mains

**WARNING ! Installation(s) must be accomplished, handled and carried out by qualified personnel only and must comply with all norms in force in the installation's country**

Power up the projector using the supplied cable.

**WARNING:NEVER CONNECT HPLED RJ ENGINE TO ANGLE PHASE DIMMER PACK NOR TO NON-DIM MODE**

## Signal control connection

HPLED DE C6 can be operated via either DMX512A and or RDM ready Protocols. For Daisy chain DMX line use a-2 lead wire plus shield.

**Important note: when DMX is available a red dot will illuminate on the right hand of the display. When red dot is off no DMX signal is available.**

Collegamento co connettore XLR5	
poli	descrizione
1	GND
2	DMX-
3	DMX+
4	NC
5	NC



## RDM – Remote Device Management

RDM Controller allows for remote standard operations.

RDM default options include:

Discovery mode: RDM is engaged when controller incepts this mode, the device reports itself by giving a flash of light (Controller sets the device in a listing to read: settings, DMX address, personality settings, (Read all DMX mode including all DMX channels above)

ON/OFF "Identify": This mode is used to identify the manufacturer's device (Lites srl).

It gives a flash of light from the LED. Model information (HPLED DE C6)

Software version information (HPLED II v.x.xx)

Mode to reveal temperatures of the LED and of the driver

Mode to reveal hour-meters of the LED and of the device

Menu items

Displayed Message	Allowed or displayed values	Function	
<b>Addr</b>	001..512	Set Up DMX Address	
<p><b>Auto</b> (Automatic mode)</p>	co01 co02 co03 co04 co05 co06 co07 co08 co09 co10 co11 co12 co13 co14 co15 co16 co17 co18 co19 co20 co21 co22 co23 co24 co25 co26 co27 co28 co29 co30 co31 co32 co33 co34 co35 co36 co37 co38 co39 co40	Preset 1 red Preset 2 light red Preset 3 orange Preset 4 medium amber Preset 5 amber Preset 6 straw tint Preset 7 pale yellow Preset 8 spring yellow Preset 9 yellow Preset 10 lemon yellow Preset 11 lime Preset 12 lime green Preset 13 green Preset 14 moss green Preset 15 light cyan Preset 16 cyan Preset 17 peacock blue Preset 18 summer blue Preset 19 bright blue Preset 20 light steel blue Preset 21 light blue Preset 22 slate blue Preset 23 blue Preset 24 deep lavender Preset 25 lavender Preset 26 magenta Preset 27 rose pink Preset 28 dark pink Preset 29 bright pink Preset 30 Rainbow Preset 31 white 2300°k Preset 32 white 2700°k Preset 33 white 3200°k Preset 34 white 4000°k Preset 35 white 5600°k Preset 36 white 6500°k Preset 37 white 7000°k Preset 38 white 8000°k Preset 39 white 9000°k Preset 40 white 10000°k	<p>It's possible to select 30 colored presets and 10 fixed white presets, without the aid of the DMX 512 signal. By selecting the value indicated from co01 to ..... co40 you choose the combined color. When you turn off the projector the selected preset will be saved. In each preset you can change the output color level. Select the preset that needs to be to be changed. If you press once the Enter button, the display will show r (red) with the set value, then if you keep pressing Enter, G (green), b (blue), A (amber), c (cyan), L (lime), S (strobe), n (Rainbow), d (dimmer) will be displayed one by one.</p> <p>Use the Up and Down button to adjust the level of the 6 colors + the 3 functions n (rainbow), S (strobe), d (dimmer), pressing them one by one from 0 to 255, to determine the output color. Always confirm with Enter to save the settings.</p>
	Pr01 Pr02 Pr03 Pr04	Program 1: auto Program 2: auto Program 3: auto Program 4: auto	<p>Automatic mode without DMX 512 Protocol signal. Program selections run between Pr01 through Pr 04. Both programs can be modified. To change program select Enter then view (Scn0...Scn6; max scenes of each program). Clicking on enter once more it shows P.00.0 (time) followed by F.00.0 (speed) and ultimately the last view shows 1c.01... though c40 (colour to be assigned to each scene) The use of UP/Down keys allow for setting values. When selections are completed press enter to confirm.</p>

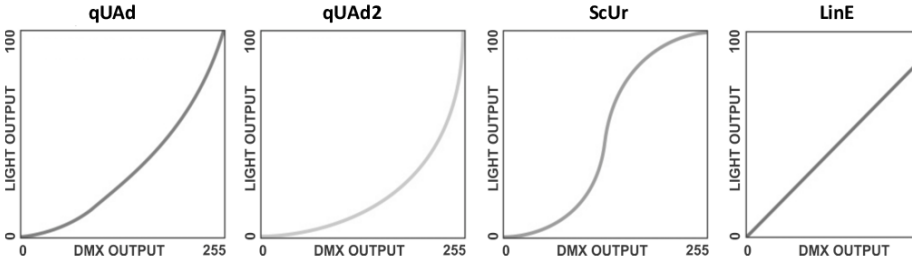
<b>MASL</b>	Master Mode	The Master Mode uses the same settings as the Auto Menu. The only exception is that when all fixtures are connected to DMX 001 in daisy-chain, they perform the same presets and or the same presets selected on the Master fixture. The slave projectors must be set in 9ch mode.	
<b>ModE</b>	12 ch (D)	RGBACL 12 ch (default)	Dmx mode (view next page)
	2 ch	2 ch	
	16 ch	RGBACL 16 ch (16 bit)	
	6 ch	RGBACL 6 ch	
	RGB	RGB 6 ch	
	HSI	Stubio HSI 6 ch	
	9ch	9 ch	
<b>drUt</b>	..°C	Shows driver operating temperature	
<b>LEdt</b>	..°C	Shows leds operating temperature	
<b>PUM</b>	0..100%	Shows current led power (0-100%)	
<b>SMoo</b>	FAST MED SLOW	DMX data Speed adjustment	
<b>GAMM</b>	qUAd SCUr qUAd2 LInE	 <p>Dimming curves available</p>	
<b>FrEq</b>	1K 2K 3K 4K 5K 6K 7K 8K 9K 10K	LED operation frequency	
<b>booS</b>	Off on	When OFF, LED max flux : 90% When ON, LED max flux : 100%	
<b>FAn</b>	Aut MEDH MEDL LOW	4 fan operating modes i.e automatic, medium fast, medium slow, slow speed. Fan speed adjustments (fan-sound) reflect on self-correct output LED brightness and other factors as room-temperature, number of engaged channels	
<b>PoS</b>	AA VV	Display orientation selection: AA = normal VV = inverted	
<b>StbY</b>	Off on	Standby display activity: off = display always switched on = display switched off after few seconds of buttons inactivity (only the right side dot will be lighted to indicate DMX availability)	
<b>dEF</b>	SURÉ	ON Will restore the default factory values	
<b>SoFt</b>		Shows Software version	

### DMX Operating Modes (Mode)

Selecting 1 of the 7 available modes it enables the number of channels required, and its relevant modes, needed to operate HPLED DE C6

**mode 12 ch RGBACL (default)**

Ch	Function	Dmx levels	
1	red	0..255	From 0 to max 255
2	green	0..255	From 0 to max 255
3	blue	0..255	From 0 to max 255
4	amber	0..255	From 0 to max 255
5	cyan	0..255	From 0 to max 255
6	lime	0..255	From 0 to max 255
7	strobe	0...15	Strobe disengaged
		16...255	Strobe from slow (16) to fast (255)
8	Rainbow	0..15	Rainbow disengaged
		16..255	Rainbow from slow (16) to fast (255)
9	dimmer	0..255	From 0 to max 255
10 (priority on channel 11)	White selection	0...15	Deserted whites
		16...17	2300°k cri 93
		18...38	from 2300°k to 2700°k
		39...40	2700°k cri 97
		41...61	from 2700°k to 3200°k
		62...63	3200°k cri 98
		64...84	from 3200°k to 4000°k
		85...86	4000°k cri 95
		87...107	from 4000°k to 5600°k
		108...109	5600°k cri 98
		110...130	from 5600°k to 6500°k
		131...132	6500°k cri 95
		133...153	from 6500°k to 7000°k
		154...155	7000°k cri 93
		156...176	from 7000°k to 8000°k
		177...178	8000°k cri 96
		179...199	from 8000°k to 9000°k
		200...201	9000°k cri 93
	202...222	from 9000°k to 10000°k	
223...225	10000°k cri 95		
	3200 ° k halogen lamp operation	226...255	halogen lamp dimming simulation
11	Color selection	0...15	No color
		16..23	red
		24...31	light red
		32...39	orange
		40...47	medium amber
		48...55	amber
		56...63	straw tint
		64...71	pale yellow
		72...79	spring yellow
		80...87	yellow
		88...95	lemon yellow
		96...103	lime
		104...111	lime green
		112...119	green
		120...127	moss green
		128...135	light cyan
		136...143	cyan
		144...152	peacock blue
		153...159	summer blue
		160...167	bright blue
		168...175	light steel blue
		176...183	light blue
		184...191	slate blue
		192...199	blue
		200...207	deep lavender
		208...215	lavender
		216...223	magenta
		224...231	rose pink
		232...239	dark pink
240...247	bright pink		
248...255	FULL RGBACL		
12	Fan speed	0..25	Auto speed or set from menu
		26..255	Fan speed from slow to fast



<b>1</b>	Color selection	0...15	No color
		16...20	red
		21...25	light red
		26...30	orange
		31...35	medium amber
		36...40	amber
		41...45	straw tint
		46...50	pale yellow
		51...55	spring yellow
		56...60	yellow
		61...65	lemon yellow
		66...70	lime
		71...75	lime green
		76...80	green
		81...85	moss green
		86...90	light cyan
		91...95	cyan
		96...100	peacock blue
		101...105	summer blue
		106...110	bright blue
		111...115	light steel blue
		116...120	light blue
		121...125	slate blue
		126...130	blue
		131...135	deep lavender
		136...140	lavender
		141...145	magenta
	146...150	rose pink	
	151...155	dark pink	
	156...160	bright pink	
	161...165	Full RGBACL	
	White selection	166...170	white 2300°k
		171...175	white 2700°k
176...180		white 3200°k	
181...185		white 4000°k	
186...190		white 5600°k	
191...195		white 6500°k	
196...200		white 7000°k	
201...205		white 8000°k	
206...210		white 9000°k	
211...215	white 10000°k		
Rainbow	216...225	Rainbow from slow (191) to fast(229) Sequence rainbow R-G-B-A-C-L	
3200 ° k halogen lamp operation	226...255	halogen lamp dimming simulation	
<b>2</b>	dimmer	0..255	From 0 to max 255

## mode 16 ch RGBACL 16 bit

Ch	Function	dmx levels	
1	red	0..255	From 0 to max 255
2	Red fine	0..255	Red fine tune adjustment
3	green	0..255	From 0 to max 255
4	Green fine	0..255	Green fine tune adjustment
5	blue	0..255	From 0 to max 255
6	Blue fine	0..255	Blue fine tune adjustment
7	amber	0..255	From 0 to max 255
8	amber fine	0..255	amber fine tune adjustment
9	cyan	0..255	From 0 to max 255
10	cyan fine	0..255	cyan fine tune adjustment
11	lime	0..255	From 0 to max 255
12	lime fine	0..255	lime fine tune adjustment
13	strobe	0...15	Strobe disingaged
		16...255	Strobo from slow (16) to fast (255)
14	dimmer	0..255	From 0 to max 255
15	Dimmer fine	0..255	Adjustment of global fine light intensity
16	Fan speed	0..25	Auto speed or set from menu
		26..255	Fan speed from slow to fast

## mode 6. ch RGBACL

Ch	Function	dmx levels	
1	red	0..255	From 0 to max 255
2	green	0..255	From 0 to max 255
3	blue	0..255	From 0 to max 255
4	amber	0..255	From 0 to max 255
5	cyan	0..255	From 0 to max 255
6	lime	0..255	From 0 to max 255

## mode 6.RGB 6 ch

<b>1</b>	Red	0..255	From 0 to max 255
<b>2</b>	Green	0..255	From 0 to max 255
<b>3</b>	Blue	0..255	From 0 to max 255
<b>4</b>	Dimmer	0..255	From 0 to max 255
<b>5</b>	strobe	0...15	Strobe disingaged
		16...255	Strobo from slow (16) to fast (255)
<b>6</b>	Fan speed	0..24	Auto speed or set from menu
		25..255	Fan speed from slow to fast

## mode 9 ch

Ch	Function	dmx levels	
1	red	0...255	From 0 to max 255
2	green	0...255	From 0 to max 255
3	blue	0...255	From 0 to max 255
4	amber	0...255	From 0 to max 255
5	cyan	0...255	From 0 to max 255
6	lime	0...255	From 0 to max 255
7	strobe	0...15	Strobo disingaged
		16...255	Strobo from slow (16) to fast (255)
8	Rainbow	0...15	Rainbow disingaged
		16...255	Rainbow from slow (16) to fast (255)
9	dimmer	0...255	From 0 to max 255

## mode 6.HSI STUDIO 6 ch

<b>1</b>	Hue	0..255	Hue selection, following levels R, R+L, R+G+L, G+L,G, G+C,G+B+C, B+C, B B+A, R+B+A, R+A, R
<b>2</b>	Saturation	0..255	Color saturation with set color in the Hue channel
<b>3</b>	Dimmer	0..255	From 0 to max 255
<b>4</b>	strobo	0...15	Strobe disingaged
		16...255	Strobo from slow (16) to fast (255)
<b>5</b> (priority on channel 1)	Selection whites	0...15	Whites off
		16...18	2300°k cri 93
		19...41	from 2300°k to 2700°k
		42...44	2700°k cri 97
		45...67	from 2700°k to 3200°k
		68...70	3200°k cri 98
		71...93	from 3200°k to 4000°k
		94...96	4000°k cri 95
		97...119	from 4000°k to 5600°k
		120...122	5600°k cri 98
		123...145	from 5600°k to 6500°k
		146...148	6500°k cri 95
		149...171	from 6500°k to 7000°k
		172...174	7000°k cri 93
		175...197	from 7000°k to 8000°k
		198...200	8000°k cri 96
201...223	from 8000°k to 9000°k		
224...226	9000°k cri 93		
227...249	from 9000°k to 10000°k		
250...255	10000°k cri 95		
<b>6</b>	Fan speed	0..24	Auto speed or set from menu
		25..255	Fan speed from slow to fast

## Error messages

In case of malfunction, the following messages can be shown:

Led sensor error: the sensor on the led is faulty.

Overtemperature LED: the temperature on the LED exceeds the allowed limit, check if the fan is working.

Micro overtemperature: the temperature on the driver board exceeds the allowed limits, check if the fan is working.

Micro sensor error: the sensor on the driver board is faulty.

If these malfunctions occur, the LED turns off.

Avoid using the HPLED DE C6 and promptly contact any authorized service centre.

## Periodical maintenance

To ensure the correct HPLED DE C6 operation, we suggest the following periodical maintenance operations:  
Remove dust or any kind of other dirt from the fans and loop-holes, this operation ensures the correct air flow

Remove dust from lenses using a clean cloth. This will ensure the maximum light efficiency

Replace damaged protection screen and lenses when necessary.

**Do not touch nor clean the LEDs nor the surrounded area with solvent**

## Device disposal information

At the end of its life, HPLED DE C6 must be disposed to an appropriate electrical and electronic equipment waste collection centre. Eco-friendly disposal, helps to avoid possible negative impact on the environment and human health and promotes the reuse and/or recycling of the materials making up the product. Illegal disposal involves administrative sanctions provided by laws enacted.



## Note

Manufacture declines any sort of personal/corporate responsibility/liability for damages caused by people that are not scrupulously following indications given in this manual as for the inadequacy or for misuse of the product they do, as well as if the product has been handled by unqualified personnel. Not complying with security norms/periodical maintenance and all information contained and as expressed in the owner's/service manual will also totally free personal/corporate responsibility/liability. Text, wordings, drawings, specifications, modifications and other changes of this manual may apply anytime without notice. The specifications are not binding.